



OUTDOOR STORAGE

MODEL N° 6424

OWNER'S MANUAL

Keep this Identification Number in case you need to contact our Customer Service Department.

IMPORTANT! PLEASE READ BEFORE BEGINNING ASSEMBLY

Dear Valued Customer,

We would like to congratulate you on your purchase of a Lifetime© Outdoor Storage Shed! We are confident that you have made the perfect choice and you will be very pleased with your new storage solution.

Lifetime© Outdoor Storage is part of the family of products created and manufactured by Lifetime® Products, Inc. Like all of our products, you can be assured that the quality of your Lifetime Outdoor Storage Shed is the best in the world! And, we back that quality up by offering the best warranty in the business – A 10-year warranty that fully covers the Shed!

All of our Sheds are built with the highest-quality steel and high-density polyethylene (HDPE) parts. The design and construction of our steel-reinforced double-Wall Panels is second to none. All of our exposed steel parts and gables are powder coated and we use high-density polyethylene plastic. What makes polyethylene so special? It has superior strength and durability, and, it won't crack or degrade outdoors.

So now that you know the quality you are getting in a Lifetime Outdoor Storage Shed, please take the time to READ THIS INSTRUCTION MANUAL!

We have taken great care in providing the best possible form of instructions to help you put your new Outdoor Storage Shed together. Before you get started, PLEASE read the following preparation tips to help you get started!

We can assure you, your construction experience will be a lot more enjoyable if you do!

PREPARATION TIPS:

- The first step is simple... RELAX! You have made a great purchase, but Rome was not built in a day. Plan to spend a good part of your weekend putting together your fine Outdoor Storage Shed. Our philosophy is, if it comes together quickly and easily, it surely will come apart quickly and easily! Your Lifetime© Outdoor Storage Shed will surely last a long, long time, if you are patient, and take all the time necessary to put it together as we have instructed.
- Grab a friend to join in on the fun! This is not a one-person endeavor. We have found that not only will things go smoother if you have two or more people participating in the construction of the Shed, but it will go quicker as well. So, the more the merrier!
- Make sure you have all the tools necessary for constructing your new Shed. There is a "Tools Required For This Assembly" list on page five of this Owner's Manual.
- The plastic pieces of your Shed may become damaged by over tightening the screws. To avoid this damage, we strongly recommend the use of a low-powered power screwdriver or a drill that has an adjustable clutch that is set on a low-torque setting. If neither is available, use a hand screwdriver. If a hand screwdriver is all you have, take several breaks... your wrist will need it!
- You will also need two small ladders (when it comes time to do the roof!).

IMPORTANT! PLEASE READ BEFORE BEGINNING ASSEMBLY

- Before beginning assembly, remove the Parts List from the center of this Owner's Manual and take an inventory of the parts included with your Outdoor Storage Shed. Also, read through the entire instruction manual. It's always a great practice to get a feel for the flow of the process and to familiarize yourself with the parts involved. But, try not to get ahead of yourself and start the process out of order.
- FOLLOW THE INSTRUCTIONS IN ORDER! Everything goes together in a certain order, and we have learned what that correct order should be. In our state-of-the-art research and testing facility, we have painstakingly created these instructions. The order of construction is there for a reason, and some parts simply will not fit if built out of order. Just follow along with the order in the instructions and everything will fit together and things will go very smooth.
- YOUR SHED MUST BE BUILT ON A LEVEL SURFACE! If the spot you have chosen to place your wonderful new Outdoor Storage Shed is not level, the Shed will not assemble correctly! We recommend a concrete patio, a wood platform or creating a pad with pea gravel. Your Shed is meant to last a lifetime, so provide the proper foundation for it before you start to build.
- Before you build it, make sure you are allowed to build it! Consult all building codes, as well as city and county ordinances, to ensure that you do not require a building permit to construct your Outdoor Storage Shed. Proper building permit documentation may be required in your neighborhood, and it would be quite unfortunate to learn this after your Outdoor Storage Shed is already built!

Now that you're ready to begin the construction of your wonderful new Outdoor Storage Shed, step back, take a deep breath, get yourself a large cold beverage and enjoy yourself. We guarantee that after spending the right amount of time in building your Shed, you will be able to enjoy it for years to come.

Thanks for choosing Lifetime®, and have fun!

ABOUT LIFETIME PRODUCTS, INC.

Lifetime Products, Inc., has applied innovation and cutting-edge technology in plastics and metals to create a family of affordable lifestyle products that feature superior strength and durability. The world's leading manufacturer of folding tables and chairs, Lifetime was founded in 1986 as the maker of portable basketball systems that revolutionized the industry with patented technology. With diverse offerings such as outdoor storage sheds and steel utility trailers, Lifetime continues to develop innovative products that outfit the way you live.

Lifetime makes the things you need for the lifestyle you want. By innovating products in and around the home, Lifetime simplifies your everyday life and enables you to get the most out of your free time.



REGISTER YOUR LIFETIME PRODUCT TODAY!

There are benefits to registering your Lifetime product. With our new online product registration form, it's fast and easy! Register with us at www.lifetime.com and enjoy these great benefits:

- Receive exclusive money-saving offers from BuyLifetime.com, our online store, as well as NEW product notifications and special closeout promotions!
- In the unlikely event of a product recall or safety modification, we will notify you.
- Registering your product guarantees you warranty service. If you do not register your product, your warranty rights will not be diminished. But you will need to provide a sales receipt to verify your product purchase date before warranty service will be provided.

LIFETIME'S PROMISE TO YOU:

Maintaining your privacy is our long-standing policy at Lifetime. And you can rest assured that Lifetime will not sell or provide your personal data to other third parties, or allow them to use your personal data for their own purposes.

We invite you to read our privacy policy at www.lifetime.com

REGISTER today!

****U.S. and Canada customers ONLY****

IF ASSISTANCE IS NEEDED,

DO NOT CONTACT THE STORE!

CALL OUR CUSTOMER SERVICE DEPARTMENT at 1 (800) 225-3865

HOURS: 7:00 a.m. to 5:00 p.m. Monday through Friday (Mountain Standard Time)

Call, or visit our Web site for Saturday hours

For customers outside the U.S. or Canada, please contact the store for assistance.



SAFETY INSTRUCTIONS



FAILURE TO FOLLOW THESE WARNINGS MAY RESULT IN SERIOUS INJURY OR PROPERTY DAMAGE AND WILL VOID WARRANTY.

To ensure safety, do not attempt to assemble this product without following the instructions carefully. Check entire box and inside all packing material for parts and/or additional instruction material. Before beginning assembly, read the instructions and identify parts using the hardware identifier and parts list in this document. Proper and complete assembly, use and supervision are essential to reduce the risk of accident or injury.

- Do not use or store hot objects such as grills, blowtorches, welding equipment, etc. near the product.
- If using a ladder during assembly, use extreme caution.
- Two capable adults are required for assembly. (It is also recommended that a third adult function as an instruction reader.)

Most injuries are caused by misuse and/or not following instructions. Use caution when using this product.

BEFORE BEGINNING ASSEMBLY



Keep the hardware bags and their contents separate. If any parts are missing, call our Customer Service Department.



Read the “Congratulations” letter on page 2-3. Identify and inventory all parts and hardware using the parts and hardware lists and identifiers in this document.

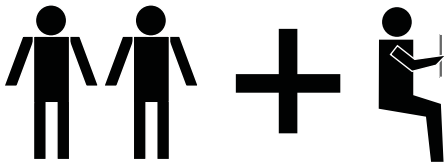

****Two adults required to complete assembly****
(+ one adult suggested as an instruction reader)

Only adults should set up the product. Do not allow children in the set-up area until assembly is complete.

IF YOU ARE INSTALLING A NEW SHED

1. Check contents of boxes and compare to parts listed on the Parts List.
2. Follow instructions that came with your shed, but add extra floor panel, wall panels, Roof Cap and Skylight at appropriate points in the assembly.

IF YOU ARE EXTENDING AN EXISTING SHED

1. Remove any bolts or screws being used to anchor the shed to the ground.
2. Remove any objects from back shelves.
3. Remove any shelves, pegboard or pegboard strips, or other objects hanging on the last two Side Wall Panels on either side.
4. Check contents of boxes and compare to parts listed on the Parts List.
5. Follow the steps in this manual.
6. If you are extending an 8' x 5' shed you will need to modify the following instructions by not removing as many parts as shown in the illustrations.



TOOLS REQUIRED FOR THIS ASSEMBLY

***Phillips Screwdriver**

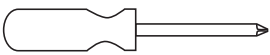

(x1)

***Electric Drill**

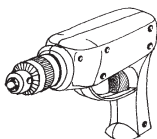

(x1)

7/16" Wrench



(x2)

3/8" Wrench



(x1)

Safety Glasses

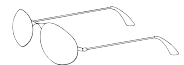

(1 pair for each person)

***See “Screwdriver Notice” on page 7.**

ASSEMBLY GUIDES

Refer to the following areas throughout the instructions to assist in the assembly process:

This area is located at the top, left-hand corner of the page and indicates which tools and hardware are needed to complete the assembly steps on a page.



TOOLS AND HARDWARE REQUIRED FOR THIS PAGE



This area is located at the top, right-hand corner of the page and shows an image of the product with shaded parts indicating which section is being assembled.



This area is usually located in the bottom, left-hand corner of a step and indicates that special attention is needed to perform a particular part of a step.



Note:

These areas are usually located in the bottom, right-hand corner of a step and indicate that damage to the product or serious injury may occur if the caution or warning is not heeded.



CAUTION



WARNING

Throughout the Parts & Hardware List, Part & Hardware Identifiers, and instructions are three-letter IDs. These IDs are below the images of the parts and hardware to help you locate and identify the parts and hardware during assembly. These IDs are not necessarily on the parts themselves.

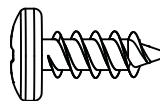

ADZ (x10)
1/4" x 5/8" Pan-Head Screw

IMPORTANT NOTICES

Level Surface Notice:

Surface must be leveled before installation. We recommend building a level work space with a concrete or patio style surface. If the surface is not properly leveled, the Outdoor Shed will not assemble correctly. Proper surface leveling will save you time in the long run, so please do not ignore this step.

Building Code Notice:

Consult all local building codes, as well as city and county ordinances, to ensure that the construction of the Outdoor Shed does not require a building permit. Proper building permit documentation may be required in your neighborhood, and it would be unfortunate to learn this after constructing the Shed.

Screwdriver Notice:

You may use a #2 Phillips head screwdriver bit and a power screwdriver or drill, instead of a hand screwdriver. However, be aware that the plastic pieces of your Shed can be damaged by overtightening of screws. To avoid damage we strongly recommend the use of a low-powered power screwdriver or a drill that has an adjustable clutch that is set on a low torque setting. If neither is available, use a hand screwdriver. In any case use caution to avoid overtightening the screws.

Floor Puncture Notice:

Sharp objects may damage your floor. If resting sharp, heavy objects on your Shed floor, place a block of wood between the sharp object and floor.



CAUTION:

If more than six (6) inches of snow accumulate on the roof of the shed, carefully remove the snow to avoid possible roof collapse. While standing on the ground, remove the snow from the roof with a broom or snow shovel. Do not stand on the roof to remove snow.

PARTS & HARDWARE LIST

ID	Description	Quantity	ID	Description	Quantity
Main Parts					
AHD	Wall Panel	1	BJM	6424 Hardware Bag	
AHH	Window Wall Panel	1	BEA	Truss Assembly Hardware	
AFX	Center Floor Panel	1	ADY	#10 x 3/8" Phillips Pan-Head Screw	6
AGQ	Roof Panel	2	ADK	#10 Cap Nut	6
AHE	Window	1	AIP	Truss Connector	1
AHC	Skylight	1	ADJ	1/4" Cap Nut	2
AFY	Center Roof Cap	1	ADH	1/4" Threaded Rod	1
AFG	Roof Truss Brace	1	BDZ	Tool Bag	
AFH	Truss Gutter Channel	2	ADC	#2 Phillips Bit	1
AFL	Roof Support Strip	2	BGT	Wall & Roof Installation Hardware	
			ADZ	1/4" x 5/8" Phillips Pan-Head Screw	45
			BGS	Skylight Installation Hardware	
			ADX	#10 X 1/2" Phillips Pan-Head Screw	6
			AED	#10 x 1" Fender Washer	6
			BEJ	Window Installation	
			AIS	Window Latch	2
			ADZ	1/4" x 5/8" Phillips Pan-Head Screw	4
			ADY	#10 x 3/8" Phillips Pan-Head Screw	1

HARDWARE IDENTIFIER

TRUSS ASSEMBLY HARDWARE [BEA]

Hardware shown at actual size (*unless otherwise indicated)

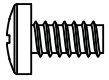

ADY (x6)
#10 x 3/8" Phillips Pan-Head Screw



ADK (x6)
#10 Cap Nut



ADJ (x2)
1/4" Cap Nut

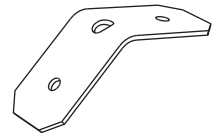

AIP (x1)*
Truss Connector

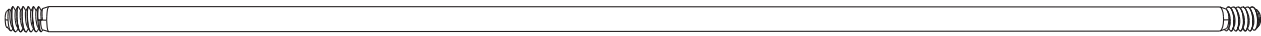

ADH (x1)*
1/4" Threaded Rod

TOOL BAG [BDZ]

Tool shown at actual size



ADC (x1)
#2 Phillips Bit

WALL & ROOF INSTALLATION HARDWARE [BGT]

Hardware shown at actual size

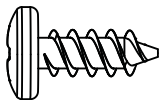

ADZ (x45)
1/4" x 5/8" Phillips Pan-Head Screw
(Not all screws will be used)

HARDWARE IDENTIFIER

SKYLIGHT INSTALLATION HARDWARE [BGS]

Hardware shown at actual size

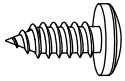

ADX (x6)
#10 x 1/2" Phillips Pan-Head Screw

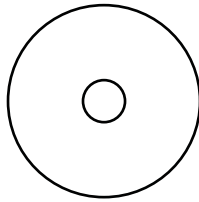

AED (x6)
#10 x 1" Fender Washer

WINDOW INSTALLATION HARDWARE [BEJ]

Hardware shown at actual size

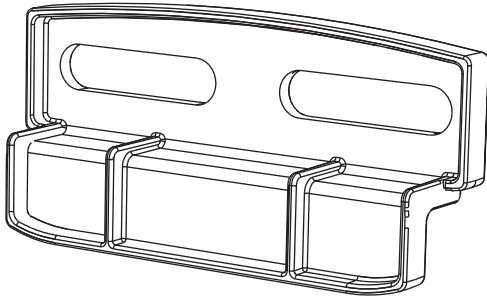

AIS (x2)
Window Latch

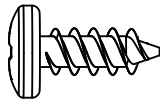

ADZ (x4)
1/4" x 5/8" Phillips Pan-Head Screw

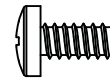

ADY (x1)
#10 x 3/8" Phillips Pan-Head Screw

PARTS IDENTIFIER

Part shown at 4% of actual size

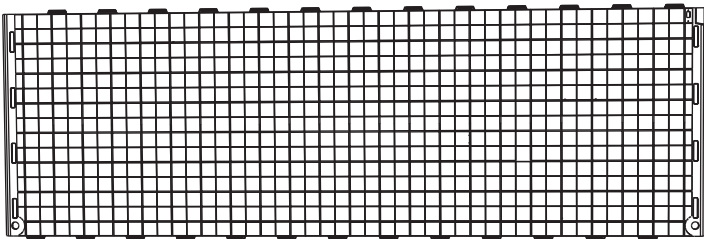

AFX (x1)
Center Floor Panel

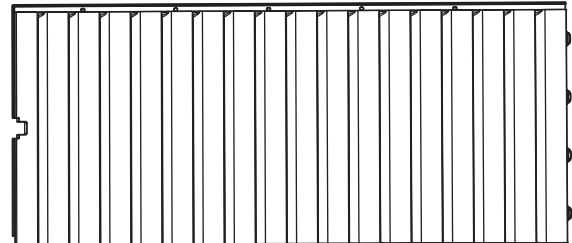

AHD (x1)
Wall Panel

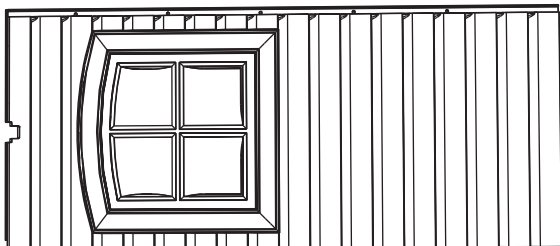

AHH (x1)
Window Wall Panel

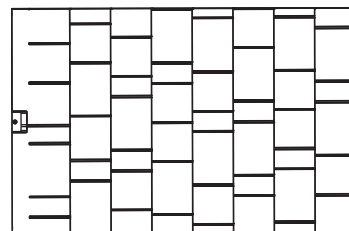

AGQ (x2)
Roof Panel

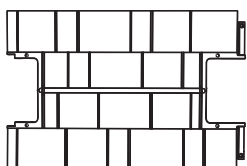

AFY (x1)
Center Roof Cap

PARTS IDENTIFIER

Parts shown at 8% of actual size



AFL (x2)*
Roof Support Strip



AFG (x1)
Roof Truss Brace

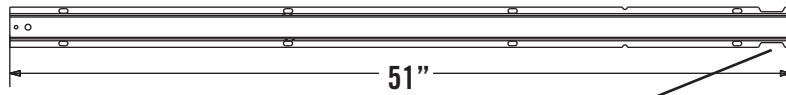
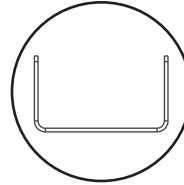

AFH (x2)
Truss Gutter Channel

Notched end goes over
Wall Panel.

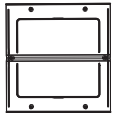
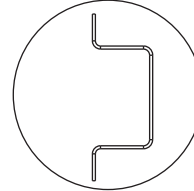

AHC (x1)
Skylight

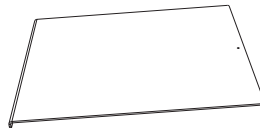

AHE (x1)
Window



Note: Throughout the Parts & Hardware List, Part & Hardware Identifiers, and instructions are three-letter IDs. These IDs are below the images of the parts and hardware to help you locate and identify the parts and hardware during assembly. These IDs are not necessarily on the parts themselves.



TOOLS AND HARDWARE REQUIRED FOR THIS PAGE

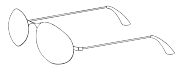
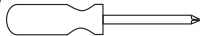

NO HARDWARE REQUIRED FOR THIS PAGE

SEC 1



****SAVE ALL HARDWARE FOR RE-ASSEMBLY!****

SEC

SHED DISASSEMBLY

1.1

Remove last three Skylights and set aside.

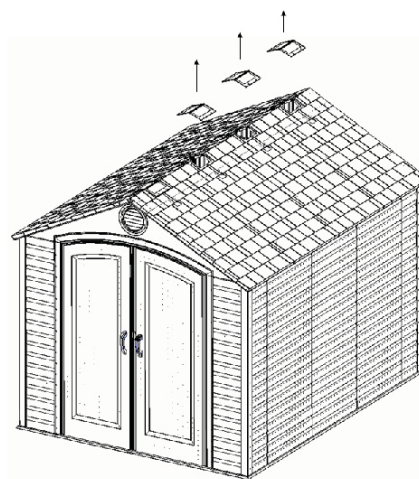

Note: Your Shed may be a different length than the Shed shown, but the ideas are the same.

SEC

1.2

Remove the back two Center Roof Caps and the End Roof Cap and set aside.

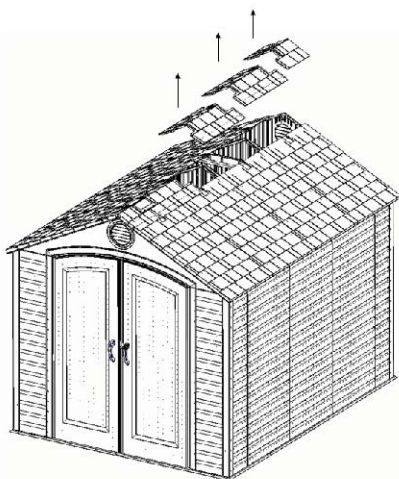

SEC

1.3

Remove the back Roof Panels and Roof Support Strips and set aside.

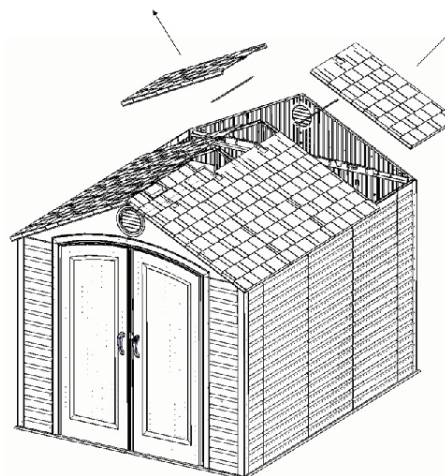



TOOLS AND HARDWARE REQUIRED FOR THIS PAGE

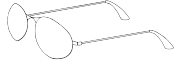

NO HARDWARE REQUIRED FOR THIS PAGE

SEC 1



****SAVE ALL HARDWARE FOR RE-ASSEMBLY!****

SEC

1.4

Remove the next Roof Panels and Roof Support Strips and set aside.

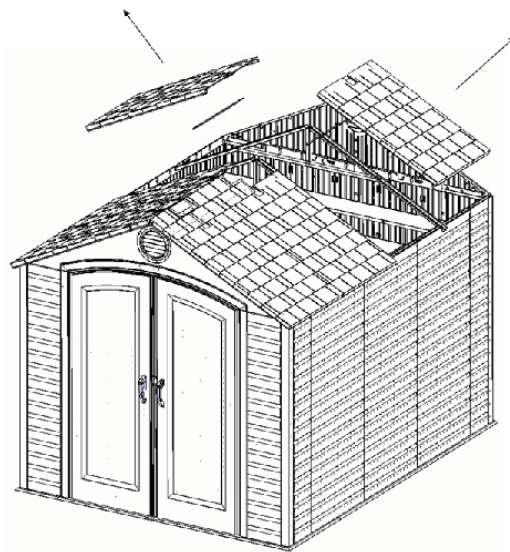

SEC

1.5

Remove the Roof Truss Assembly and set aside.

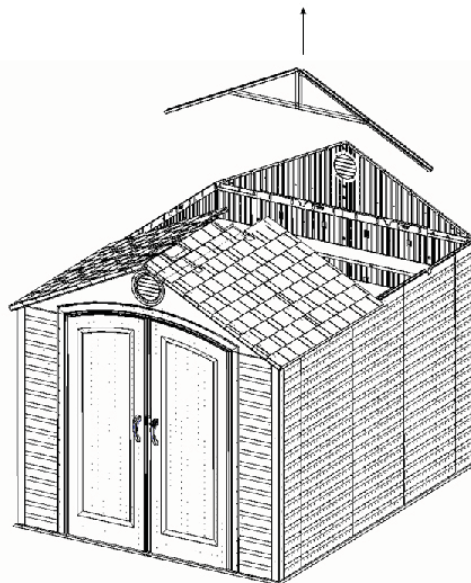



TOOLS AND HARDWARE REQUIRED FOR THIS PAGE

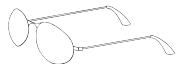
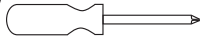

NO HARDWARE REQUIRED FOR THIS PAGE

SEC 1



****SAVE ALL HARDWARE FOR RE-ASSEMBLY!****

SEC

1.6

Remove the last two side Wall Panels and set aside.

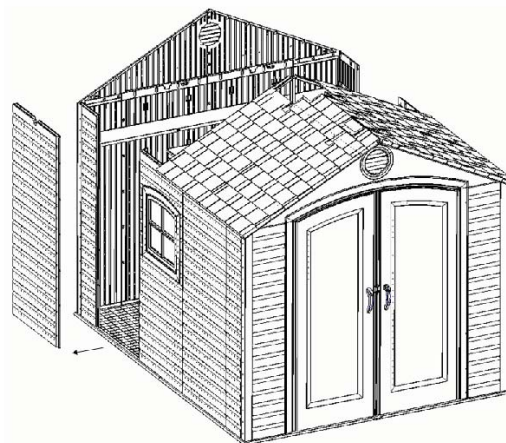
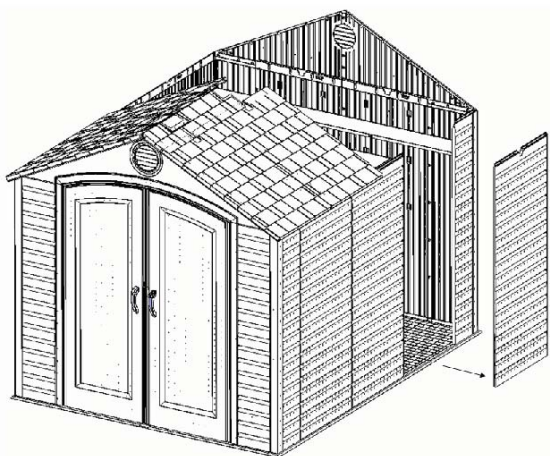

SEC

1.7

Slide the rear section of the Shed away from the front. You will need to tip the rear section forward slightly in order to disconnect the Floor Panels

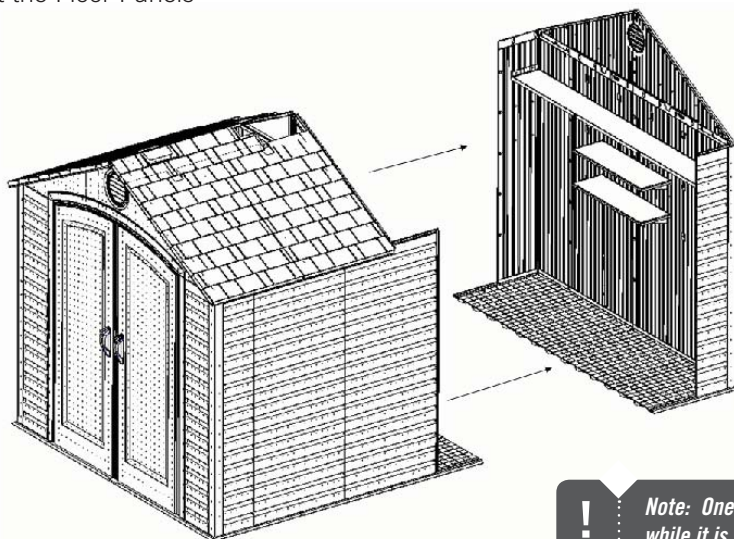

Note: One person should support the rear Wall while it is being tipped and moved.



Note: Ensure there is nothing on the rear Shelves before moving the rear section of the Shed.

SEC 2 FLOOR ASSEMBLY

HARDWARE REQUIRED

NO HARDWARE REQUIRED FOR THIS SECTION

METAL PARTS REQUIRED

NO METAL PARTS REQUIRED FOR THIS SECTION

PLASTIC PARTS REQUIRED

Part shown at 4% of actual size

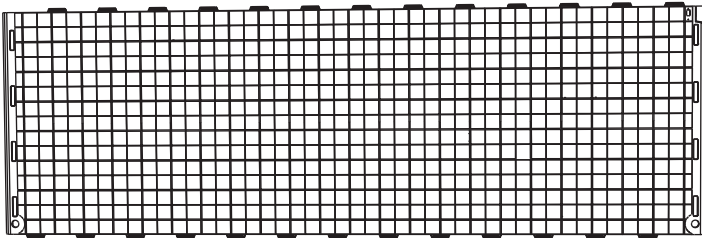

AFX (x1)
Center Floor Panel

TOOLS REQUIRED

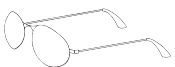

Safety Glasses



TOOLS AND HARDWARE REQUIRED FOR THIS PAGE

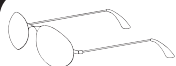

NO HARDWARE REQUIRED FOR THIS PAGE

SEC 2

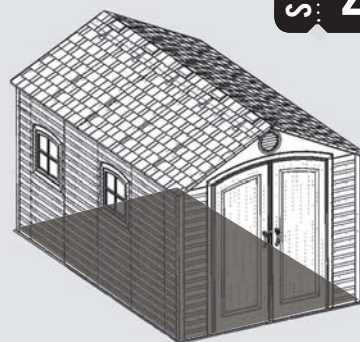

SEC

2.1

Add new **Center Floor Panel (AFX)**. Then, slide the rear section into place and connect the Floor Panels. You will need to tip the rear section forward slightly to connect the Center Floor Panels.

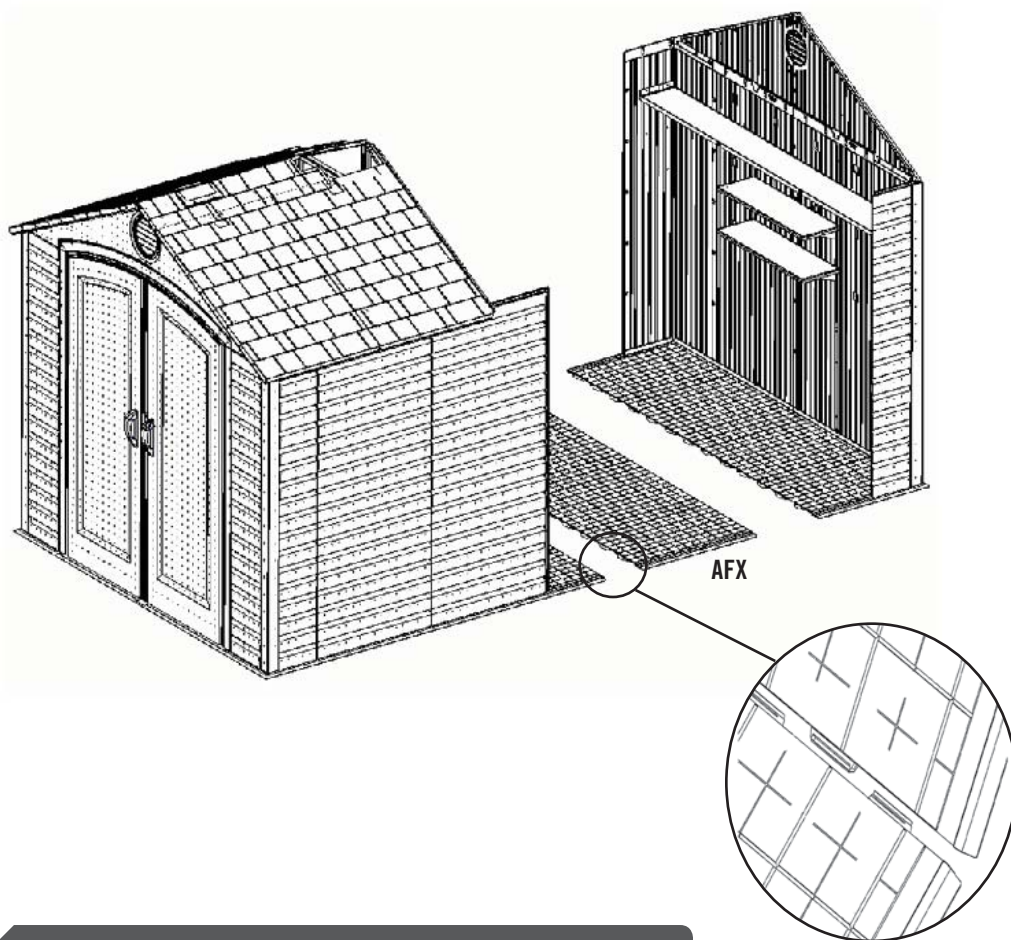

AFX



Note: Tip up one floor panel and line up tabs and then lay floor panel flat.

SEC 3 TRUSS ASSEMBLY

HARDWARE REQUIRED

Hardware shown at actual size



METAL PARTS REQUIRED

Parts shown at 8% of actual size (*Unless indicated otherwise)

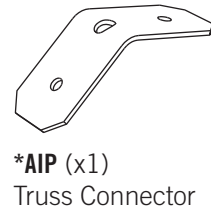
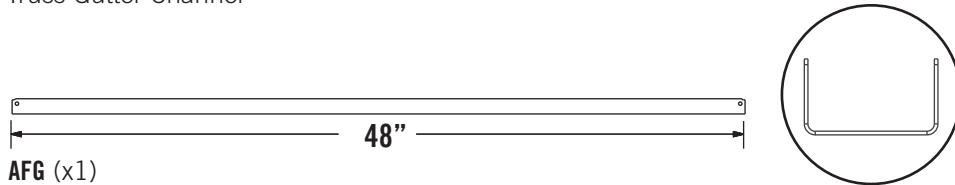
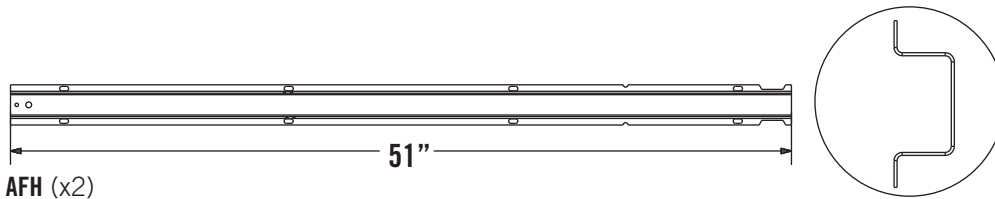

Part shown at 50% of actual size

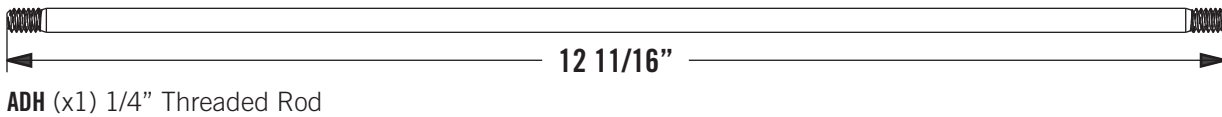

PLASTIC PARTS REQUIRED

NO PLASTIC PARTS REQUIRED FOR THIS SECTION

TOOLS REQUIRED



Phillips Screwdriver

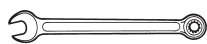

7/16" Wrench



3/8" Wrench

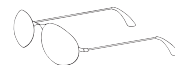

Safety Glasses



TOOLS AND HARDWARE REQUIRED FOR THIS PAGE

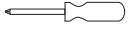

3/8"

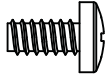

ADY (x1)



ADK (x1)

SEC 3

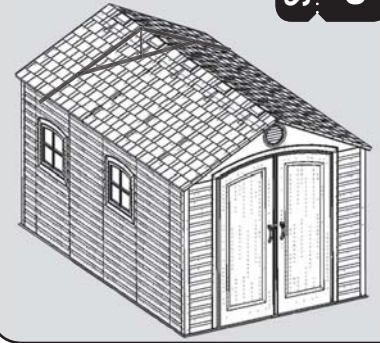

SEC

TRUSS ASSEMBLY

3.1

Stand a **Truss Gutter Channel (AFH)** upright and set a **Truss Connector (AIP)** inside the end of the Channel as shown. Align the holes and secure with one (1) #10 x 3/8" Pan-Head Screw (**ADY**) and one (1) #10 Cap Nut (**ADK**).

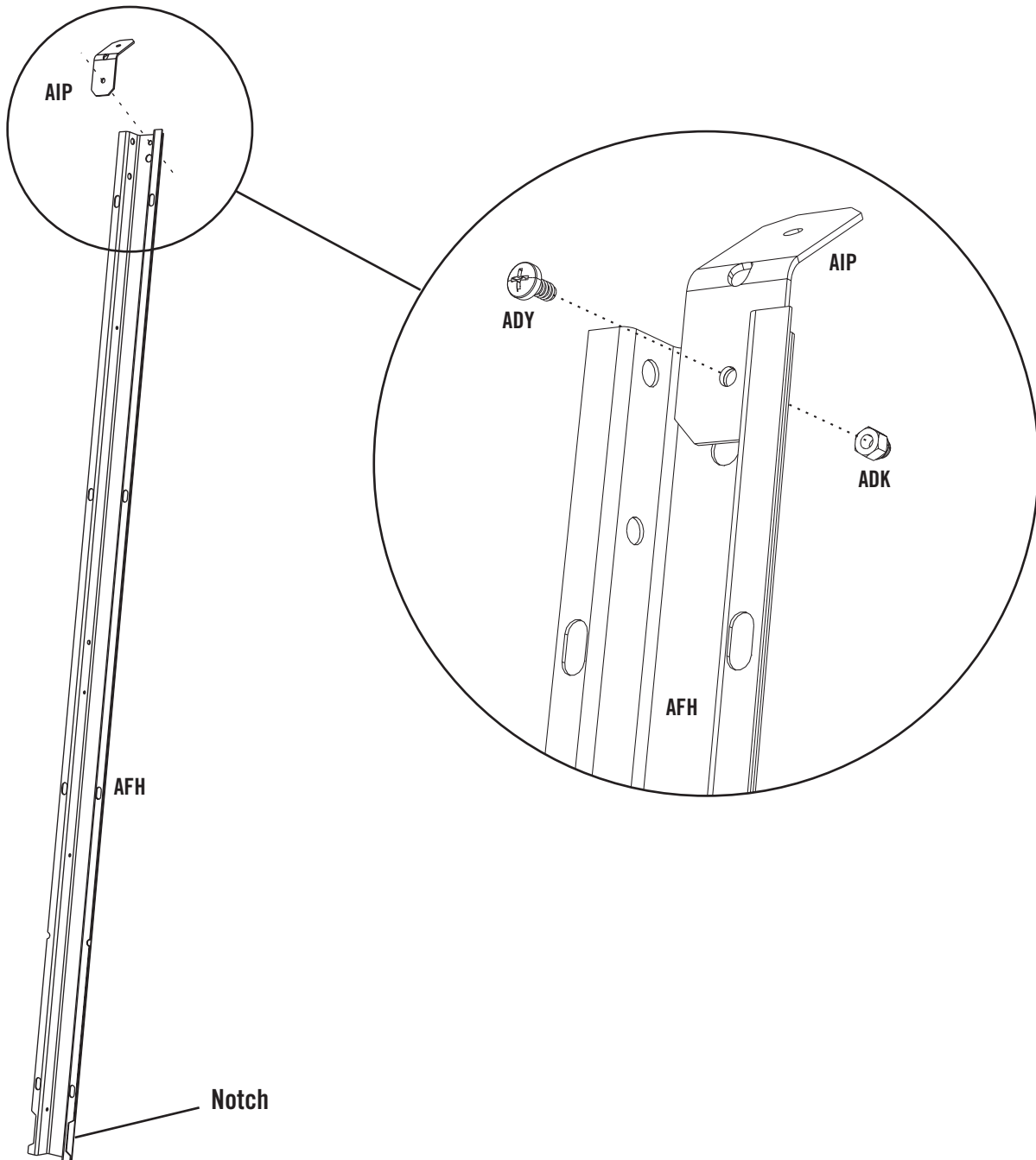



TOOLS AND HARDWARE REQUIRED FOR THIS PAGE

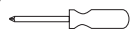

3/8"

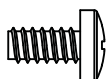

ADY (x1)



ADK (x1)

SEC. 3



SEC

3.2

Connect another **Truss Gutter Channel (AFH)** to the Truss Connector using one (1) **#10 x 3/8" Pan-Head Screw (ADY)** and one (1) **#10 Cap Nut (ADK)**.

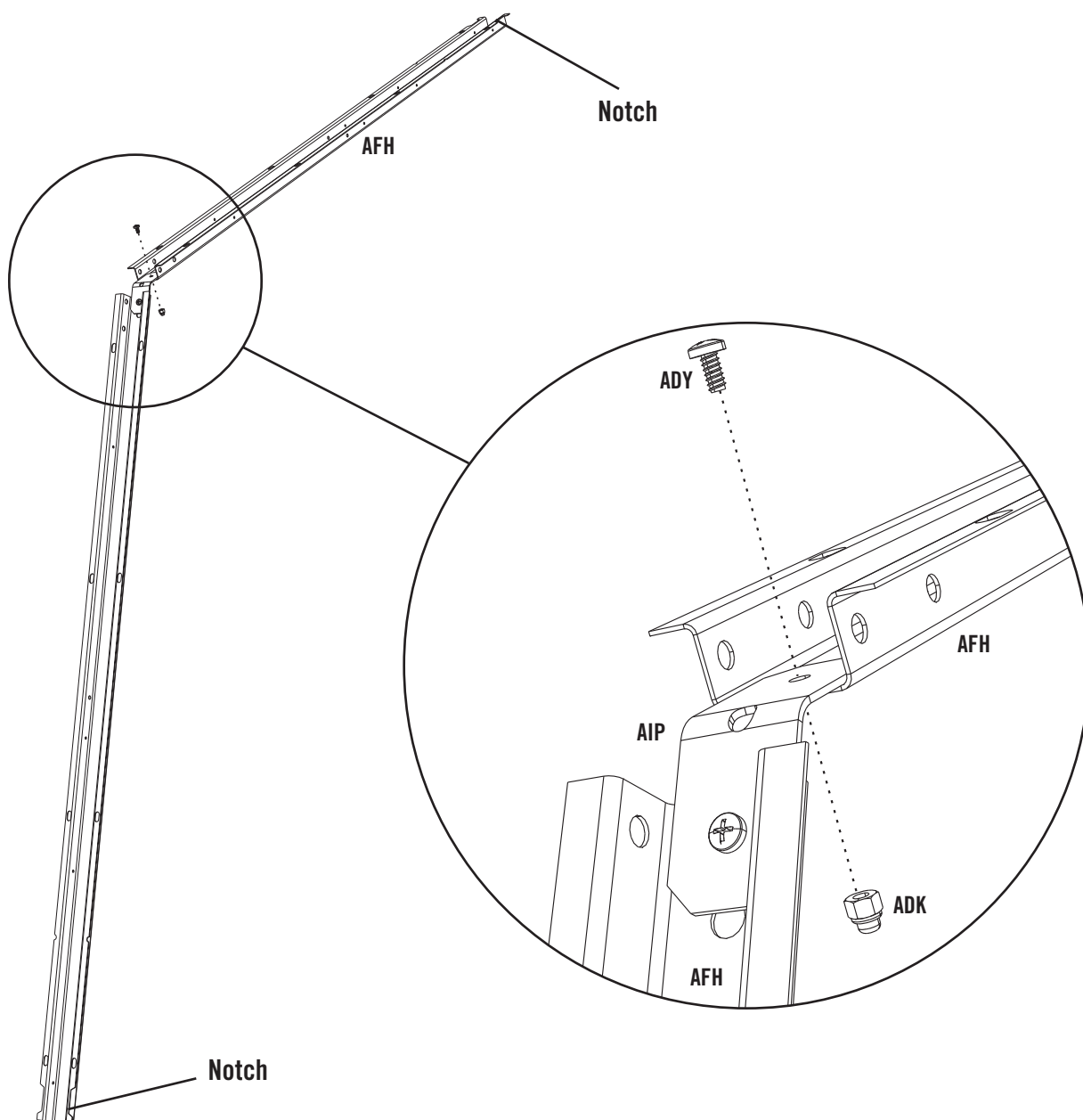



TOOLS AND HARDWARE REQUIRED FOR THIS PAGE

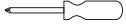

3/8"

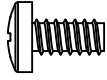

ADY (x4)



ADK (x4)

SEC 3

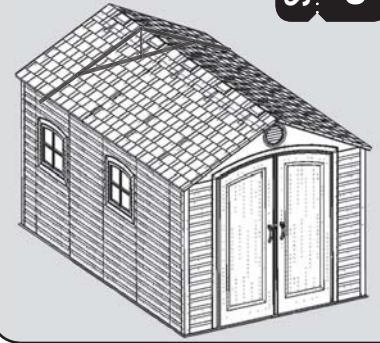

SEC

3.3

Lay the Truss Assembly on its side, and align the holes in a **Roof Truss Brace (AFG)** with those circled on the Truss Gutter Channels as shown.

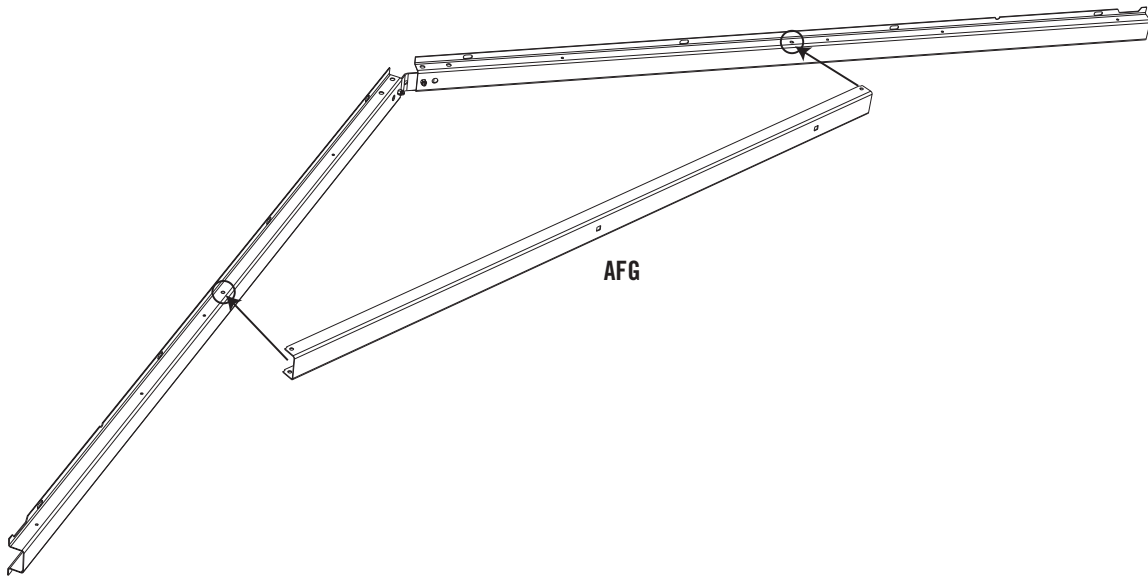

SEC

3.4

Secure the Roof Truss Brace to the Truss Gutter Channel using two (2) **#10 x 3/8" Pan-Head Screws (ADY)** and two (2) **#10 Cap Nuts (ADK)**. Repeat this step for the other end of the Roof Truss Brace.

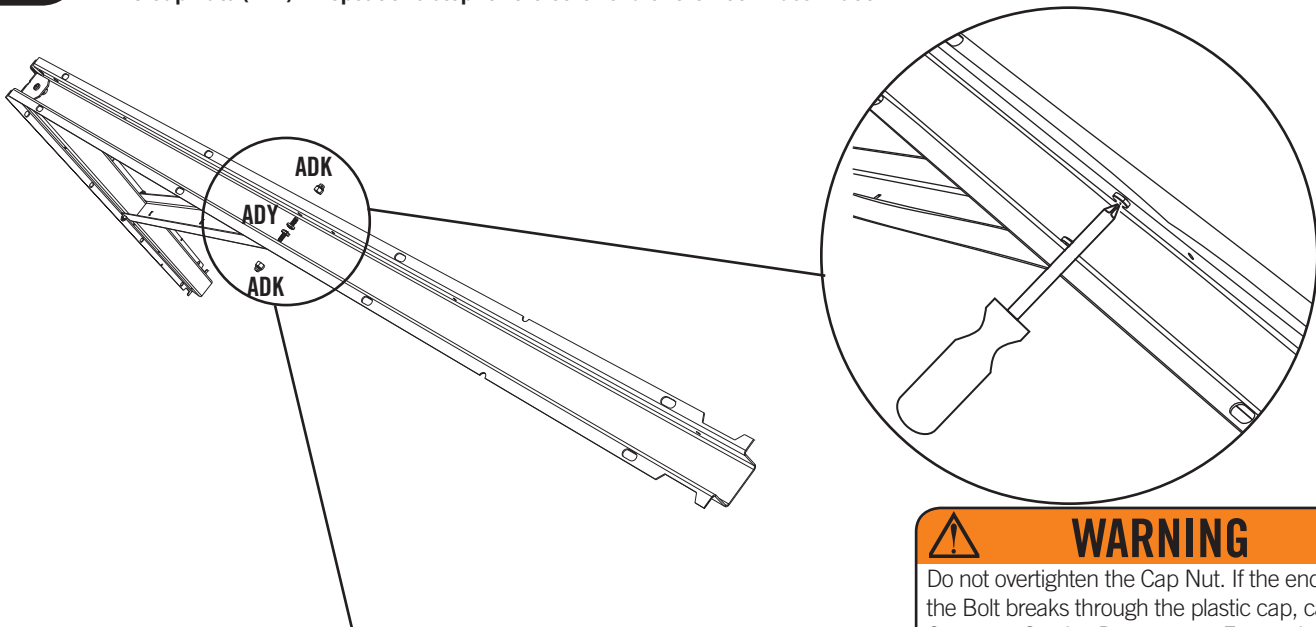

Note: The Cap Nuts goes on the outside of the Truss.



WARNING

Do not overtighten the Cap Nut. If the end of the Bolt breaks through the plastic cap, call our Customer Service Department. Exposed threads on the end of the Bolt may cause serious injuries.



TOOLS AND HARDWARE REQUIRED FOR THIS PAGE



7/16" (x2)



ADJ (x2)

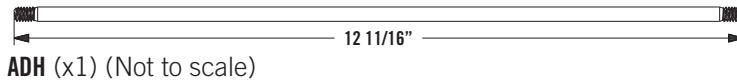

ADH (x1) (Not to scale)

SEC. 3

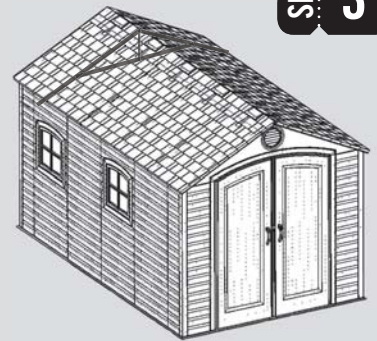

SEC

3.5

With the Truss Assembly on its side, slide a **1/4" Threaded Rod (ADH)** through the Roof Truss Brace and Truss Connector as shown. Secure the top and bottom of the 1/4" Threaded Rod with a **1/4" Cap Nut (ADJ)**. Tighten all hardware. The 1/4" Threaded Rod will still spin freely. Set aside.

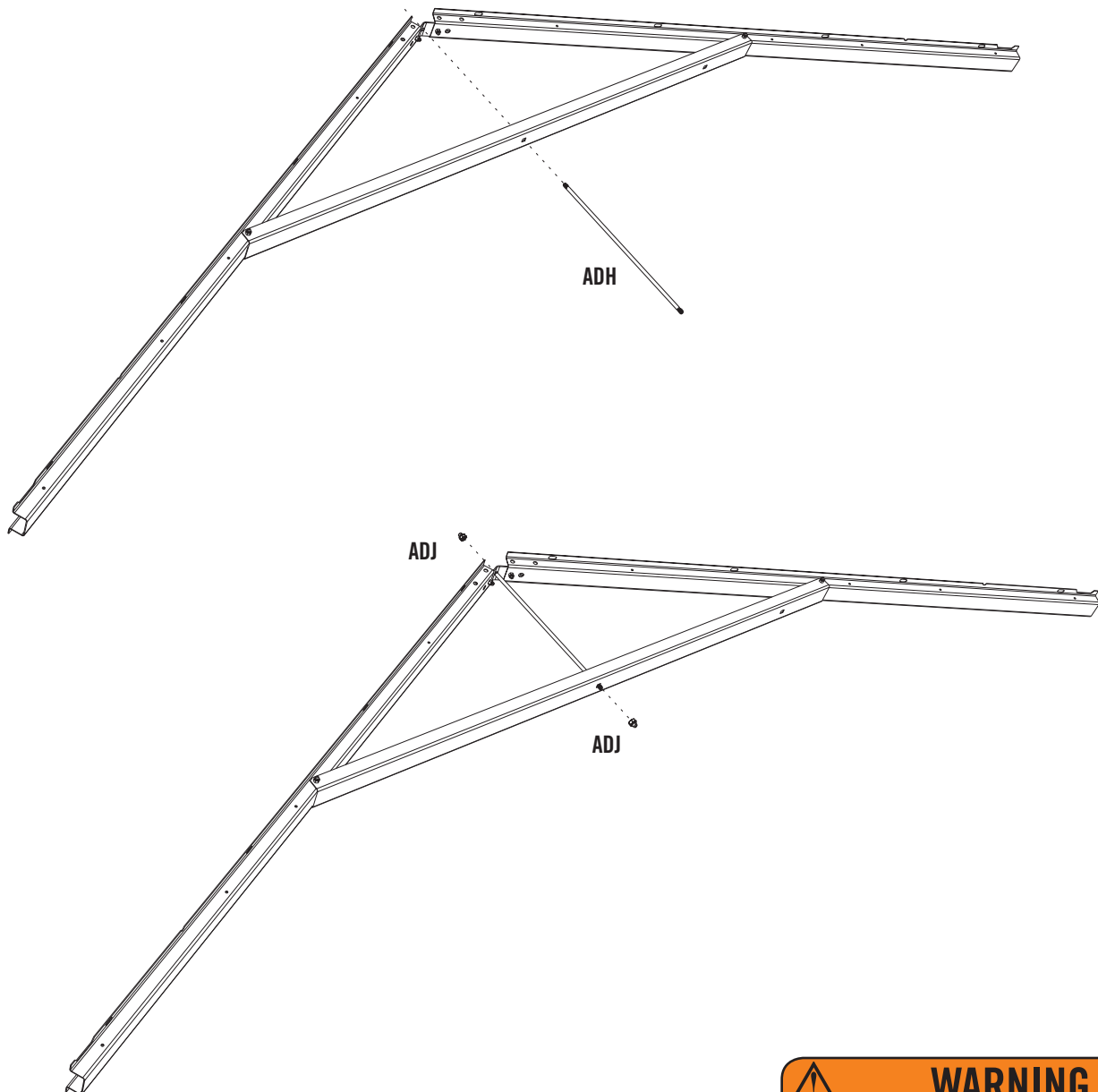

WARNING

Do not overtighten the Cap Nut.

SEC 4 WALL & ROOF INSTALLATION

HARDWARE REQUIRED

Hardware shown at of actual size

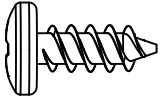

ADZ (x45)
1/4" x 5/8" Phillips Pan-Head Screw
(Not all screws will be used)

METAL PARTS REQUIRED

Parts shown at 8% of actual size



AFL (x2)
Roof Support Strip

PLASTIC PARTS REQUIRED

Parts shown at 4% of actual size

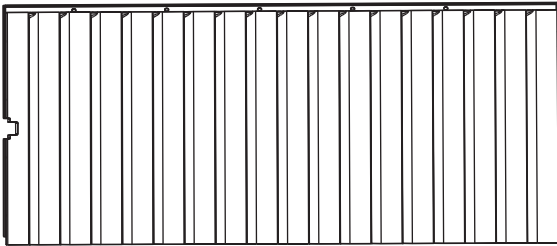

AHD (x1)
Wall Panel

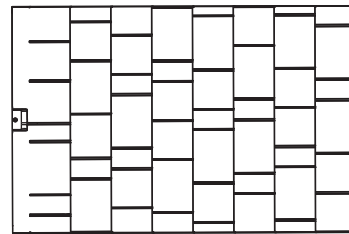

AGQ (x2)
Roof Panel

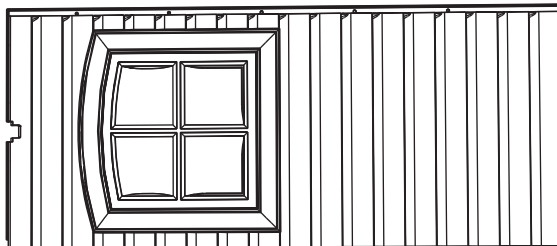

AHH (x1)
Window Wall Panel

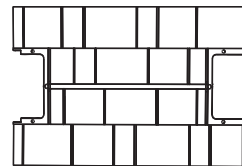

AFY (x1)
Center Roof Cap

TOOLS REQUIRED

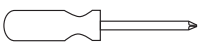

Phillips Screwdriver

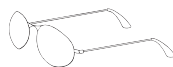

Safety Glasses



TOOLS AND HARDWARE REQUIRED FOR THIS PAGE

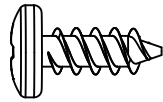

ADZ (x10)

SEC 4

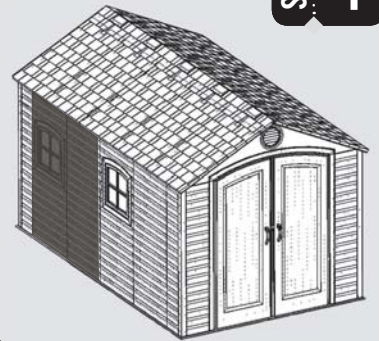

USE THE 1/4" X 5/8" PHILLIPS PAN-HEAD SCREWS YOU REMOVED IN SECTION 1 TO HELP COMPLETE THE ASSEMBLY ON THIS PAGE

SEC

4.1

Secure new **Wall Panel (AHD)** and **Window Wall Panel (AHH)**, along with the Panels you removed, to the Shed using the Screws you removed from the Shed during disassembly and the 1/4" X 5/8" Phillips Pan-Head Screws (ADZ) furnished with this kit. You may insert the Window Wall Panel in any Wall Panel location.

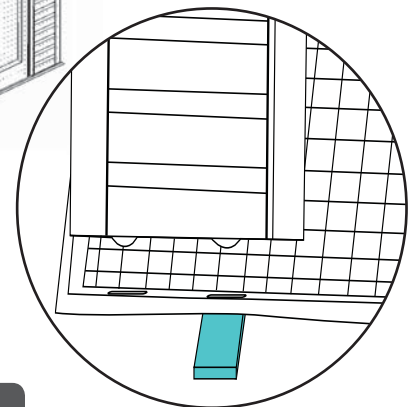
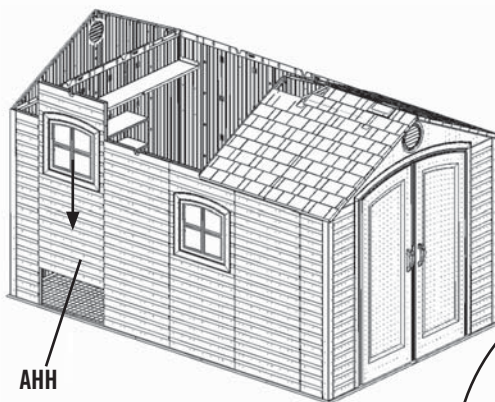
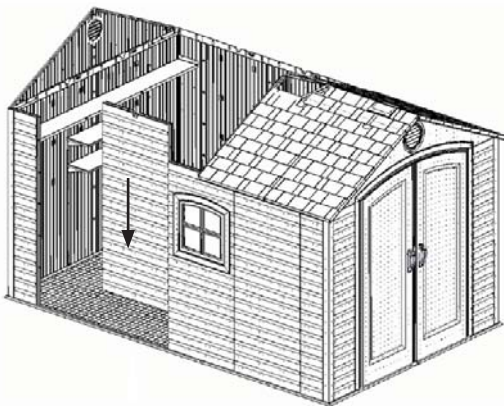
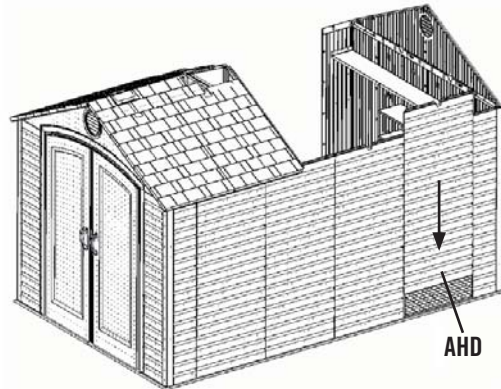
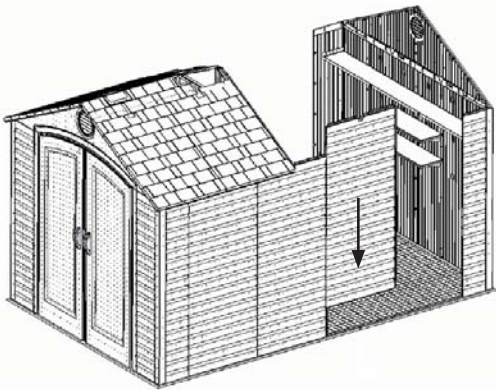

Note: Insert a wood block directly under the tab you want to insert, then slide block to next tab and repeat.



TOOLS AND HARDWARE REQUIRED FOR THIS PAGE



NO NEW HARDWARE REQUIRED FOR THIS PAGE

SEC 4



USE THE 1/4" X 5/8" PHILLIPS PAN-HEAD SCREWS YOU REMOVED IN SECTION 1 TO HELP COMPLETE THE ASSEMBLY ON THIS PAGE

SEC

4.2

Install the Truss Assembly you removed in Section 1.

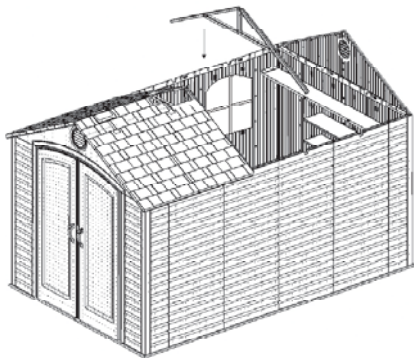

SEC

4.3

While one adult holds the Truss Assembly in place, attach the Roof Panels and Roof Support Strips you removed in Section 1.

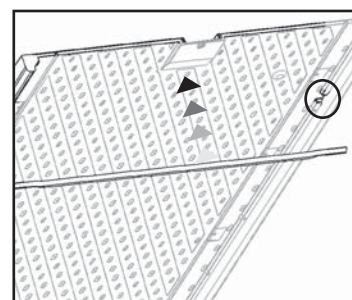
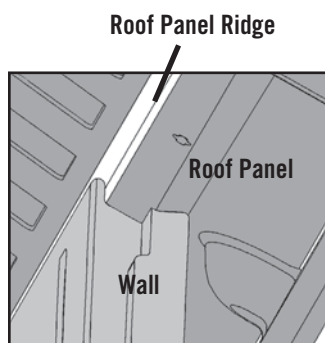
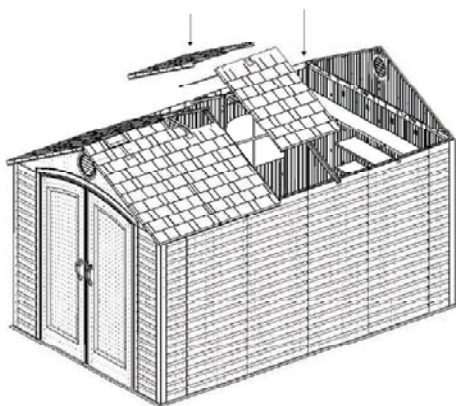



TOOLS AND HARDWARE REQUIRED FOR THIS PAGE

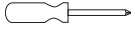

NO NEW HARDWARE REQUIRED FOR THIS PAGE

SEC 4

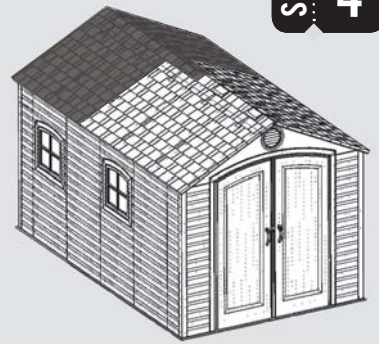

USE THE 1/4" X 5/8" PHILLIPS PAN-HEAD SCREWS YOU REMOVED IN SECTION 1 TO HELP COMPLETE THE ASSEMBLY ON THIS PAGE

SEC

4.4

Attach a Center Roof Cap you removed in Section 1.

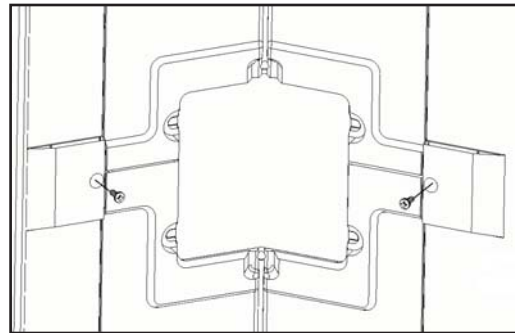
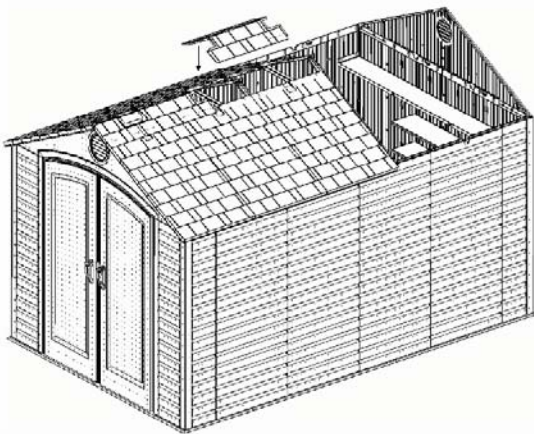

SEC

4.5

Install the Truss Assembly you assembled in Section 3.

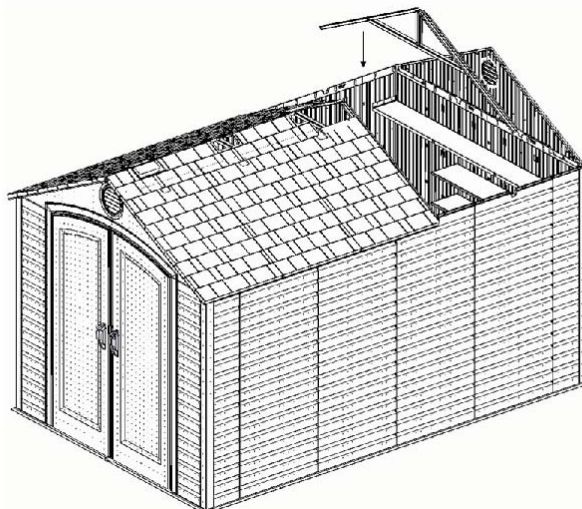



TOOLS AND HARDWARE REQUIRED FOR THIS PAGE

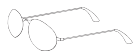

SEC 4

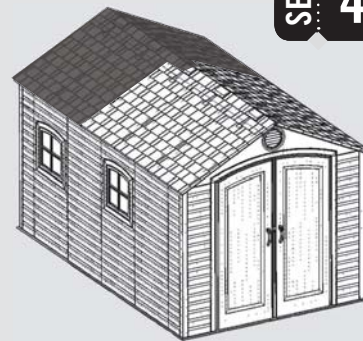

USE THE 1/4" X 5/8" PHILLIPS PAN-HEAD SCREWS YOU REMOVED IN SECTION 1 TO HELP COMPLETE THE ASSEMBLY ON THIS PAGE

SEC

4.6

Install the **Roof Panels (AGQ)** and **Roof Support Strips (AFL)** using the hardware furnished with this kit.

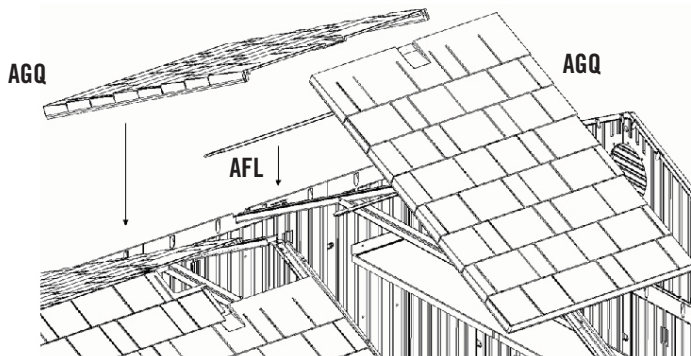

SEC

4.7

Install a Center Roof Cap you removed in Section 1 using the hardware from Section 1.

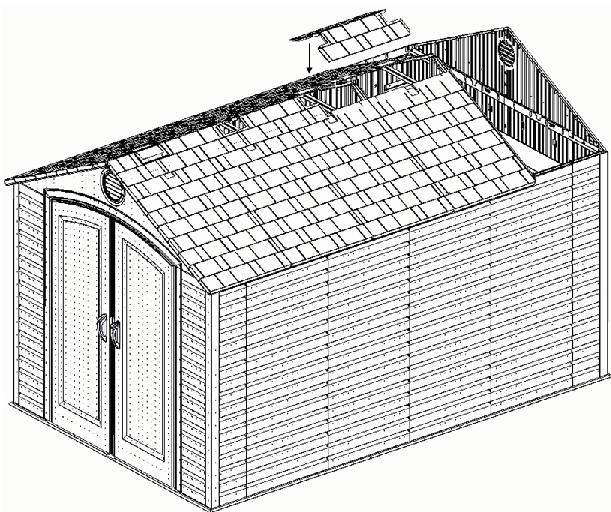

SEC

4.8

Install the Roof Panels and Roof Supports you removed in Section 1 using the hardware from Section 1.

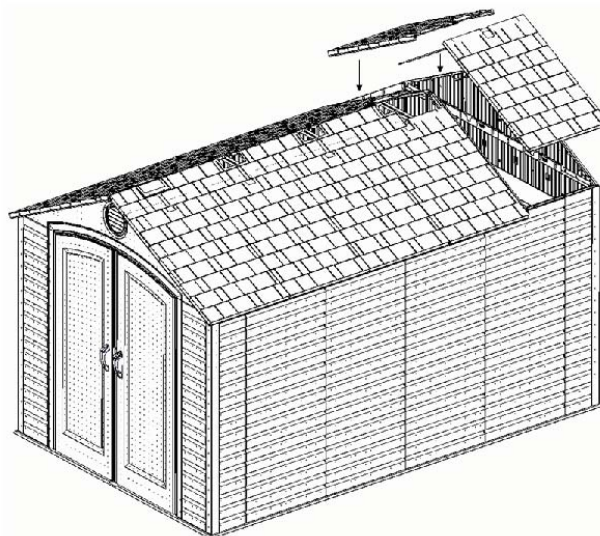



TOOLS AND HARDWARE REQUIRED FOR THIS PAGE

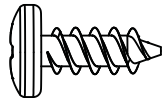
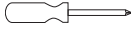

ADZ (x6)

SEC 4

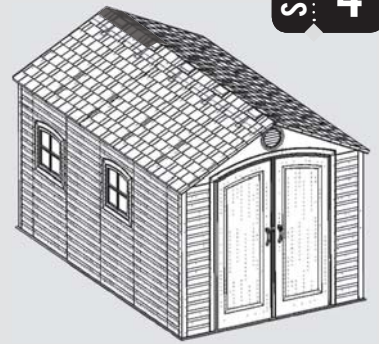

USE THE 1/4" X 5/8" PHILLIPS PAN-HEAD SCREWS, THE #10 X 1/2" PHILLIPS PAN-HEAD SCREWS, AND THE #10 X 1" FENDER WASHERS YOU REMOVED IN SECTION 1 TO HELP COMPLETE THE ASSEMBLY ON THIS PAGE

SEC

4.9

Install the **Center Roof Cap (AFY)** furnished with this kit and the End Roof Cap you removed in Section 1 using the hardware you removed in Section 1 and the hardware furnished with this kit.

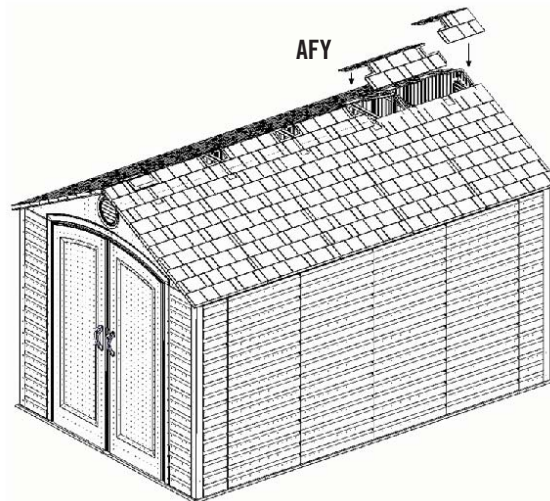

SEC 5 SKYLIGHT INSTALLATION

HARDWARE REQUIRED

Hardware shown at of actual size

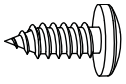

ADX (x6)
#10 x 1/2" Phillips Pan-Head Screw

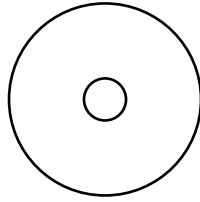

AED (x6)
#10 x 1" Fender Washer

METAL PARTS REQUIRED

NO METAL PARTS REQUIRED FOR THIS SECTION

PLASTIC PARTS REQUIRED

Part shown at 8% of actual size

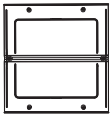

AHC (x1)
Skylight

TOOLS REQUIRED



Phillips Screwdriver

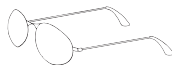

Safety Glasses



TOOLS AND HARDWARE REQUIRED FOR THIS PAGE

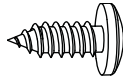
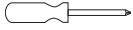

ADX (x6)

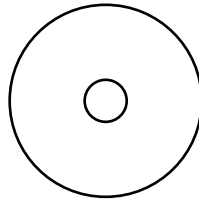

AED (x6)

SEC 5

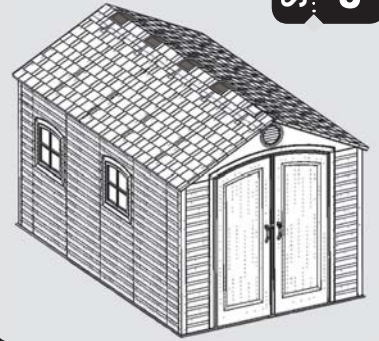

SEC

5.1

Install the Skylights you removed in Section 1 and the **Skylight (AHC)** furnished with this kit using the required hardware.

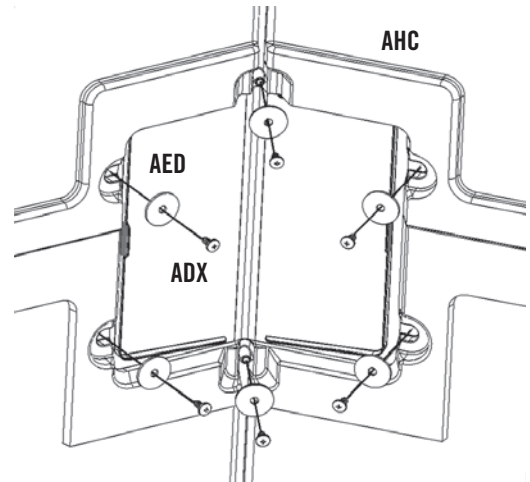
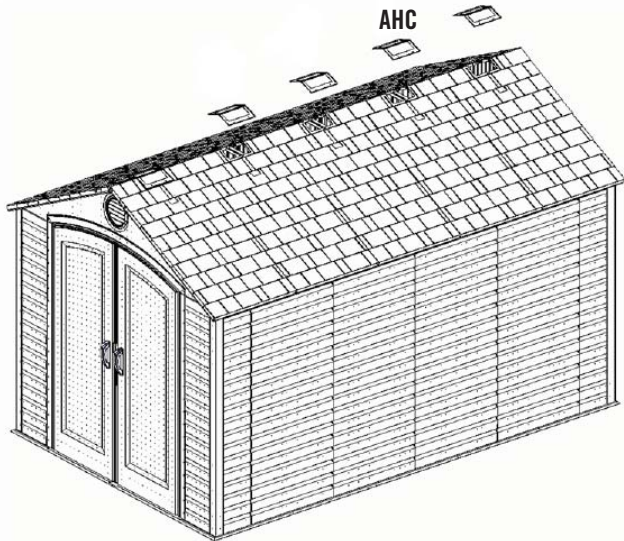

SEC 6 WINDOW INSTALLATION

HARDWARE REQUIRED

Hardware shown at of actual size

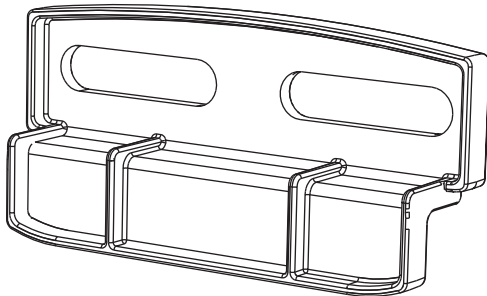

AIS (x2)
Window Latch

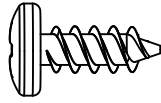

ADZ (x4)
1/4" x 5/8" Phillips Pan-Head Screw

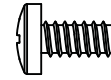

ADY (x1)
#10 x 3/8" Phillips Pan-Head Screw

METAL PARTS REQUIRED

NO PLASTIC PARTS REQUIRED FOR THIS SECTION

PLASTIC PARTS REQUIRED

Part shown at 4% of actual size



AHE (x1)
Window

TOOLS REQUIRED



Phillips Screwdriver

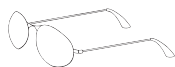

Safety Glasses



TOOLS AND HARDWARE REQUIRED FOR THIS PAGE

SEC 6

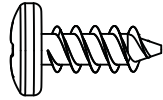
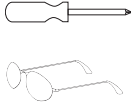

ADZ (x4)

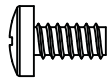

ADY (x1)

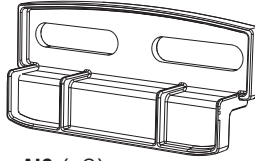

AIS (x2)

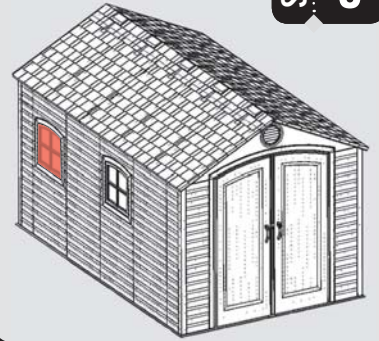

SEC

6.1

Remove plastic sheeting from **Window (AHE)** and slide Window into slot on the Window Wall Panel. Attach a **Window Latch (AIS)** above each corner of the Window as shown. When tightening the **1/4" x 5/8" Phillips Pan-Head Screws (ADZ)**, ensure the Window Latches slide freely. Do not overtighten. Insert the **#10 x 3/8" Phillips Pan-Head Screw (ADY)** into the hole in the Window.

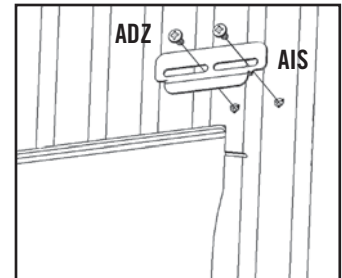
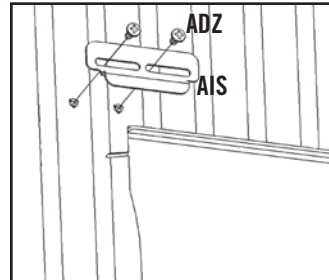
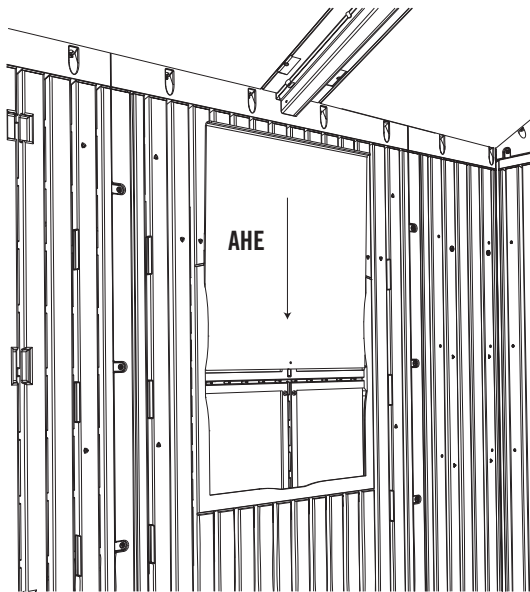

Note: Insert window with bent edge at top and pointing away from the wall.

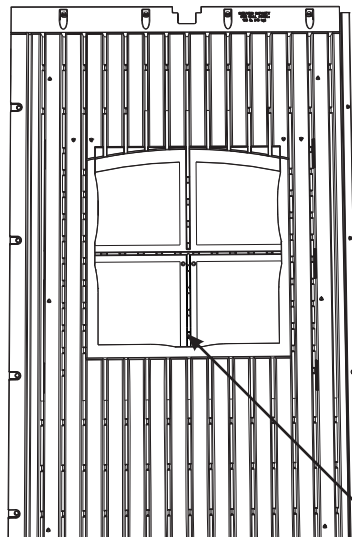

Note: Place Screw (ADY) in this hole to keep window from sliding up too far. Insert until flush with the window.

LIFETIME OUTDOOR SHED EQUIPMENT

10-YEAR LIMITED FACTORY WARRANTY

THE MANUFACTURER RESERVES THE RIGHT TO MAKE SUBSTITUTIONS TO WARRANTY CLAIMS IF PARTS ARE UNAVAILABLE OR OBSOLETE.

1. Lifetime outdoor sheds are warranted to the original purchaser to be free from defects in material or workmanship for a period of ten years from the date of original retail purchase. The word "defects" is defined as imperfections that impair the use of the product. Defects resulting from misuse, abuse or negligence will void this warranty. This warranty does not cover defects due to improper installation, alteration or accident. This warranty does not cover damage caused by vandalism, rusting, "acts of nature" or any other event beyond the control of the manufacturer.
2. This warranty is nontransferable and is expressly limited to the repair or replacement of defective product. If the product is defective within the terms of this warranty, Lifetime Products, Inc. will repair or replace defective parts at no cost to the purchaser. Shipping charges to and from the factory are not covered and are the responsibility of the purchaser. Labor charges and related expenses for removal, installation or replacement of the shed or its components are not covered under this warranty.
3. This warranty does not cover scratching or scuffing of the product that may result from normal usage. In addition, defects resulting from intentional damage, negligence, unreasonable use or hanging from the truss will void this warranty.
4. Liability for incidental or consequential damages is excluded to the extent permitted by law. While every attempt is made to embody the highest degree of safety in all equipment, freedom from injury cannot be guaranteed. The user assumes all risk of injury resulting from the use of this product. All merchandise is sold on this condition, and no representative of the company may waive or change this policy.
5. This product is not intended for institutional or commercial use; Lifetime Products, Inc. does not assume any liability for such use. Institutional or commercial use will void the warranty.
6. This warranty is expressly in lieu of all other warranties, expressed or implied, including warranties of merchantability or fitness for use to extent permitted by Federal and state law. Neither Lifetime Products, Inc., nor any representative assumes any other liability in connection with this product. This warranty gives you specific legal rights, and you may also have other rights which vary from state to state.

ALL WARRANTY CLAIMS MUST BE ACCOMPANIED BY A SALES RECEIPT.

REPORT PRODUCT DEFECTS IN WRITING TO:

Lifetime Products, Inc., PO Box 160010 Clearfield, UT 84016-0010
or call (800) 225-3865 M-F 7 a.m. to 5 p.m. MST.

Please include your dated sales receipt and photographs of damaged parts.

To register the product, visit our Web site at www.lifetime.com



www.lifetime.com

©2004 Lifetime Products, Inc.

PO Box 160010 • Freeport Center, Bldg. D-11 Clearfield, Utah 84016-0010
T: 800-225-3865 • F: 801-728-1907

ENHANCE YOUR LIFETIME® PURCHASE BY ADDING ACCESSORIES OR OTHER GREAT PRODUCTS

To purchase accessories or other Lifetime Products, visit us at:

www.lifetime.com

Or call: 1-800-424-3865

